

The Influence of IR Absorption and Backscatter Radiation from CO₂ on Air Temperature during Heating in a Simulated Earth/Atmosphere Experiment

Thorstein O. Seim¹, Borgar T. Olsen^{2,3}

¹Former Senior Research Scientist at Nycomed Pharma, Oslo, Norway

²Former Research Fellow at Max-Planck-Institute for Physiological and Clinical Research, Munich, Germany

³Former Research Scientist at Telenor (Televerkets) Research Department, Fornebu, Norway

Email: thorstein.seim@gmail.com

How to cite this paper: Seim, T.O. and Olsen, B.T. (2020) The Influence of IR Absorption and Backscatter Radiation from CO₂ on Air Temperature during Heating in a Simulated Earth/Atmosphere Experiment. *Atmospheric and Climate Sciences*, 10, 168-185.

<https://doi.org/10.4236/acs.2020.102009>

Received: February 23, 2020

Accepted: April 17, 2020

Published: April 20, 2020

Copyright © 2020 by author(s) and Scientific Research Publishing Inc. This work is licensed under the Creative Commons Attribution International License (CC BY 4.0).

<http://creativecommons.org/licenses/by/4.0/>



Open Access

Abstract

The Greenhouse Effect was simulated in a laboratory setup, consisting of a heated ground area and two chambers, one filled with air and one filled with air or CO₂. While heating the gas the temperature and IR radiation in both chambers were measured. IR radiation was produced by heating a metal plate mounted on the rear wall. Reduced IR radiation through the front window was observed when the air in the foremost chamber was exchanged with CO₂. In the rear chamber, we observed increased IR radiation due to backscatter from the front chamber. Based on the Stefan Boltzmann's law, this should increase the temperature of the air in the rear chamber by 2.4 to 4 degrees, but no such increase was found. A thermopile, made to increase the sensitivity and accuracy of the temperature measurements, showed that the temperature with CO₂ increased slightly, about 0.5%.

Keywords

Greenhouse Effect, Radiative Forcing, CO₂ Backscatter, IR Radiation

1. Introduction

In 1859 John Tyndall [1] published his famous experiments, showing how infrared (IR) radiation was absorbed in “greenhouse” gases like water vapor, carbon dioxide (CO₂) and methane (CH₄), laying the foundation for the theory that increased CO₂ in the air leads to a warmer climate. This Greenhouse effect, illustrated in **Figure 1**, can be described as follows.

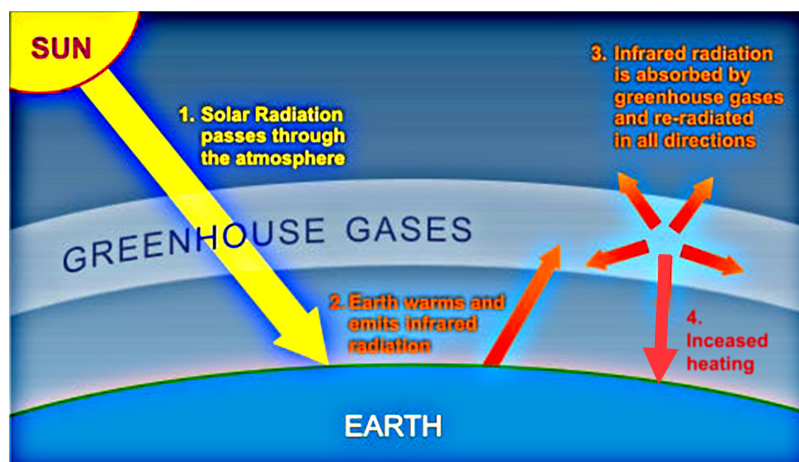

Figure 1. Illustration of the Greenhouse Effect due to greenhouse gases, mainly CO₂ and water vapor [2].

- 1) The atmosphere is transparent to short-wave solar radiation that warms the surface of the Earth.
- 2) The heated soil and water emit long-wave radiation (IR radiation).
- 3) The IR radiation is captured by greenhouse gases and then sent out (emitted) in all directions.
- 4) Part of the emitted radiation (back radiation or backscatter) from greenhouse gases returns to the Earth's surface and contributes to increased surface temperature; the rest is leaving the atmosphere. Humans' increased emissions of greenhouse gases lead to an enhanced Greenhouse Effect.

This explanation is used by IPCC (the Intergovernmental Panel on Climate Change) and others [3] [4] [5]. The IR backscatter from the greenhouse gases in the atmosphere has been identified by several types of measurements, both by satellites and at ground level [6] [7] [8] [9]. However, no direct measurement was made of the resulting heating of the ground. IPCC admits that the amount of heating is still discussed and that the enhanced greenhouse effect from CO₂ has only been confirmed by empirical evidence [10]. To our knowledge, no carefully performed experimental measurement of the temperature effect of CO₂ absorption of IR and the resulting backscatter on the IR radiating surface has been presented in the literature.

The illustration in **Figure 1** gave us the idea of how to perform an experiment to study the Greenhouse Effect. By separating the air above the ground from the CO₂ greenhouse gas we could study how the air was warmed from increasing amount of IR backscatter. This could be done as indicated in **Figure 2**.

In this simulated atmosphere/ground situation the ground, heated by the sun, is replaced by a warm black painted metal plate. The atmosphere above the "ground" is divided into two chambers, one above the "ground", filled with air, and one on the top that can contain air or CO₂. The heated metal plate emits IR-radiation that either leaves the container through the window on top, or is partly absorbed when CO₂ is filled in the top compartment. The absorbed IR

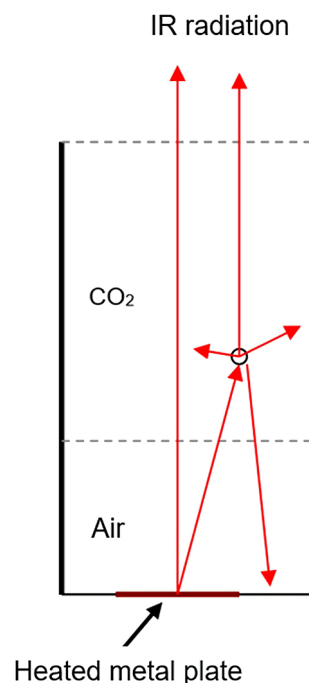

Figure 2. Simulation of the greenhouse effect for use in a laboratory experiment.

radiation is then emitted in all directions, including backscatter that is returned to the air-filled bottom chamber. A thin window that does not, or very slightly, absorb IR radiation should be placed between the two chambers and on top of the container, indicated by broken lines in the figure. In the experiment, we shall measure the IR radiation and the temperatures in the two chambers. In addition, we will calculate the expected temperature changes in the air-filled bottom chamber, caused by changes in IR absorptions and backscatter.

2. The Experiment

The motivation for our setup is to create an experiment which could demonstrate the effect of not only doubling the CO₂ concentration but to increase it by more than 2000 times.

The theory, used by IPCC to predict the warming of the Earth, is called radiative forcing. Radiative forcing F (in W/m²) is defined by IPCC as: “Change in energy flux caused by natural or anthropogenic drivers of climate change” [11]. The standard formula for the contribution from CO₂ is [12] [13]:

$$\Delta F = 5.35 \times \ln \left(\frac{C}{C_0} \right) \quad (1a)$$

and

$$\Delta T = \lambda \times \Delta F \quad (1b)$$

where ΔF is the increase in CO₂ backscatter radiation in W/m², C is the concentration of CO₂, C_0 is the reference concentration in preindustrial times and ΔT is the resulting increase in temperature. The constant λ is ca. 0.8. In the IPCC cli-

mate report [14] it is estimated that a doubling of CO₂ concentration in air will result in an IR forcing of 3.7 W/m² and about 3 °C higher temperature. Let us use Equation (1a) to estimate what we can expect of temperature changes during warming.

In our experiment, the CO₂ concentration will increase from ca 0.04% (in air) to close to 100%. Based on $\ln(100/0.04) = 7.82$, this will increase the forcing to $\Delta F = 41.9$ W/m² and ΔT to ca 33 °C. However, we do not expect such a large temperature response, since many atmospheric factors influence the constants in Equation (1a) and Equation (1b).

Since we are measuring the small ΔT and ΔF a competing formula is the differential Stefan-Boltzmann law:

$$\Delta T = \frac{\Delta F}{4\sigma T^3} \quad (2)$$

where $\sigma = 5.67 \times 10^{-8}$ W/(m²K⁴) and T is the temperature in Kelvin. For temperatures around 300 K gives the factor λ about 0.16. In addition, the length of the CO₂ filled chamber should be large enough to provide a substantial absorption of IR radiation. From the Equation (1a) and Equation (1b), we therefore should expect a measurable temperature increase in the rear chamber. This is the core of the climate models, and we wanted to get experimental evidence for the dominating contribution from the CO₂. The rear chamber with air should not change during the different experiments (with different gases in the front chamber).

2.1. Experimental Setup

For practical reasons the setup, shown in **Figure 2**, was placed horizontally, not vertically. **Figure 3** shows the experimental arrangement. The top and the bottom chamber in **Figure 2** represent the front and rear chamber in **Figure 3**.

The one meter long box, with a volume of 150 liters, is made of insulating 5 cm thick Styrofoam plates. The two chambers are separated by a thin EDTA (Ethylenediaminetetraacetic acid) plastic film that transmits more than 90% of visual light and IR radiation. The window in the front of the foremost chamber was also made of EDTA. The Styrofoam walls of the chambers (except the rear wall) are covered by thin Al-foil. The Al-foil reflects most of the IR radiation and thereby reduces the heat loss through the walls. The length of the rear and front chamber is 30 and 70 cm, respectively. IR radiation was produced by warming a metal plate, painted with heat-resistant, mat black paint, and mounted on the rear wall of the rear chamber. The rear wall, with an area of 0.15 m², is made from Styrofoam.

The area of the metal plate is 0.036 m². An increase in backscatter IR intensity with CO₂ in the front chamber should then give us measurable changes in temperature of the rear wall and in the air in the rear chamber.

A thermometer, measuring the gas temperature, was placed close to the roof in each chamber and screened from radiation from the metal plate. (The temperature sensor is encapsulated in polished metal that reflects IR radiation).

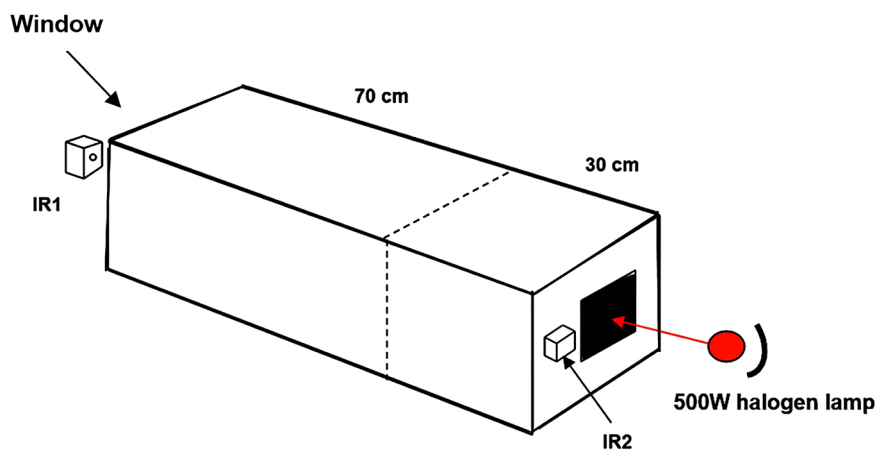

Figure 3. Experimental setup. A black-painted Al-plate (or a black-painted Al-foil) is heated by a 500 W halogen lamp. The distance to the lamp was adjusted to warm the plate to about 100°C. An IR radiation detector is located in front of the window on the box (IR1). Another detector is placed behind the box (IR2) and measures IR backscatter radiation via a 6 × 6 cm window in the rear wall, covered with EDTA film. The IR2 detector is shielded from the heating lamp with a wall of Styrofoam (not shown in the figure). In order to reduce the heating by the lamp of the outside rear Styrofoam wall (surrounding the black metal plate), the wall was covered with reflecting Al-foil. Small holes were made in the top of the two chambers to obtain constant pressure during heating.

The temperature of the rear Styrofoam wall was measured with a thermocouple, painted black (in order to absorb IR radiation). To avoid local convection and temperature gradients in the two chambers a small fan with reduced speed is placed in each chamber.

To measure absorption of IR radiation and the backscatter generated by CO₂, two IR detectors were constructed and calibrated (IR1 and IR2). The CO₂ concentration in the two chambers was measured with a self-calibrating CO₂ gauge (ELMA DT-802D. Maximum: 10,000 ppm. Resolution: 1 ppm).

2.2. Measuring IR Emission, Absorption and Backscatter

Our measurements of IR radiation should be compared with previous measurements. Data for IR absorption in CO₂ can be found in the HITRAN [15] spectroscopic archive. **Figure 4** shows the absorption of IR-radiation from 100% CO₂ in a metal tube with a variable length [16]. The IR-measurement spectral range is from 10 to 22 μm. The IR source is a metal plate, heated to 100°C.

The absorption A of IR radiation in the tube closely follows the function

$$A = 0.0188 \times \ln(x) + 0.1228 \quad (3)$$

where x is the length in meter of the tube (the Beer-Lambert law). From this function, we estimate that in the 0.7 m long front chamber the IR absorption should be 11.6%.

The two IR detectors IR1 and IR2 use thermopile detectors [17]. The output signal is amplified by using operational amplifiers. The radiation response of the detectors is measured in mV. We have calibrated the sensors to measure IR

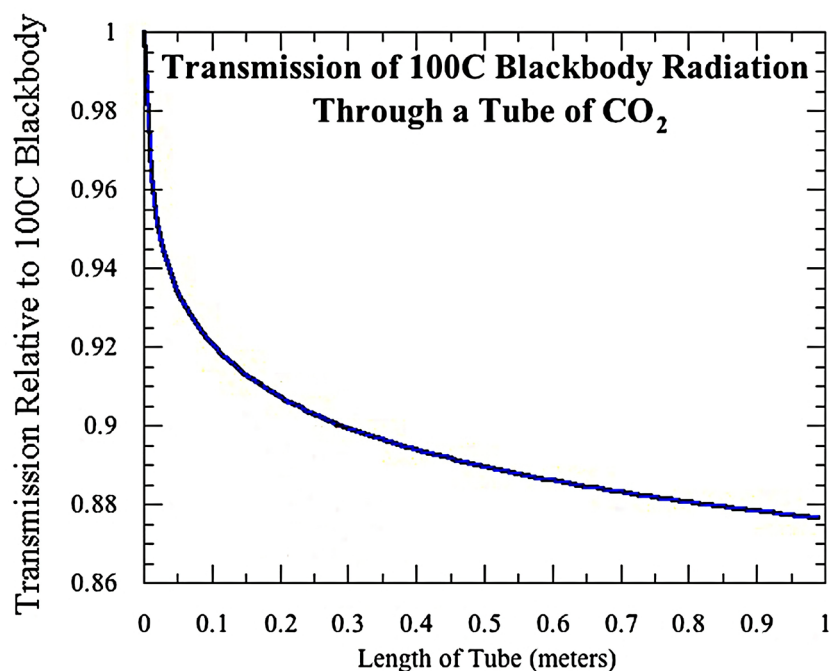

Figure 4. IR radiation transmission with 100% CO₂ in a tube with a length of up to 1 meter [16]. The IR-measurement range is from 10 to 22 μm .

radiation E in W/m^2 from a black body source. The detectors and the calibration procedure are described in **Appendix**.

2.3. Expected Experimental Results Based on the Greenhouse Effect

Assume first that we have air in both chambers. When the back wall starts to heat, the IR radiation from it increases. The Al foil on the walls inside the two chambers will reflect most of the IR radiation out through the front window. The strength of the escaping IR radiation can then be measured by the IR1 detector.

With CO₂ in the front chamber, we expect that the IR radiation that is absorbed by the CO₂ gas will reduce the amount of IR radiation out the front window. This reduction can be measured with the IR1 detector. Most of the absorbed IR radiation energy will then be returned to the rear wall and absorbed. The strength of this IR backscatter can be measured by the IR2 detector. This added energy will heat the rear wall and this will increase the temperature of the air in the rear chamber, according to the Greenhouse Effect. Without thermal losses we expect the IR output to increase again and stabilize at the same value found when the front chamber was filled with air.

To summarize:

- 1) We expect a warming effect of the back chamber and rear wall.
- 2) We do not expect any long term reduction of IR out of the front window.
- 3) We do expect increased IR density in the rear chamber.

However, we must expect some loss of the absorbed IR energy due to thermal

losses through the walls of the two chambers.

3. Experimental Results

3.1. Measurements with Air, CO₂ and Argon in the Front Chamber

In the first experiment we measured the gas temperatures when the black-painted Al-plate on the rear wall of chamber was heated to ca. 100°C with the 500 W halogen lamp. **Figure 5** shows the average (mean) of 5 temperature curves for the two chambers, obtained when the front chamber is filled with air (with 400 to 450 ppm CO₂) or close to 100% CO₂. During heating the temperature of the rear chamber increases from 20°C to 46.5°C, and the front chamber from 20°C to ca. 32°C. We do not observe any significant difference in the two curves due to the increase in the CO₂ concentration from ca 400 ppm to about 100% in the front chamber.

The rear wall of the box, surrounding the heated metal, consists of white Styrofoam. In order to check if the rear Styrofoam wall was heated by IR backscatter, a small, black-painted thermocouple was mounted on the wall (screened from radiation from the metal plate).

The results are shown in **Figure 6**. No measurable extra heating of the rear wall was found with CO₂ in the front chamber. The warming of the Al-plate was also measured, but no extra heating was found by filling CO₂ in the front chamber. (The temperature was measured with a Fluke 62 Max IR thermometer).

3.2. Measurements of Absorbed IR Radiation

IR radiation out of the front chamber window was measured by the IR1 detector, placed in front of the window and pointing at the Al-plate in the rear wall. When CO₂ is filled in the front chamber, the IR-output from the plate and out through the front window is reduced, as shown in **Figure 7**.

From Equation (3) we found that the absorption is 11.6% for a 70 cm long tube. Heating with the black Al-plate (**Figure 7**) increased the IR energy out of

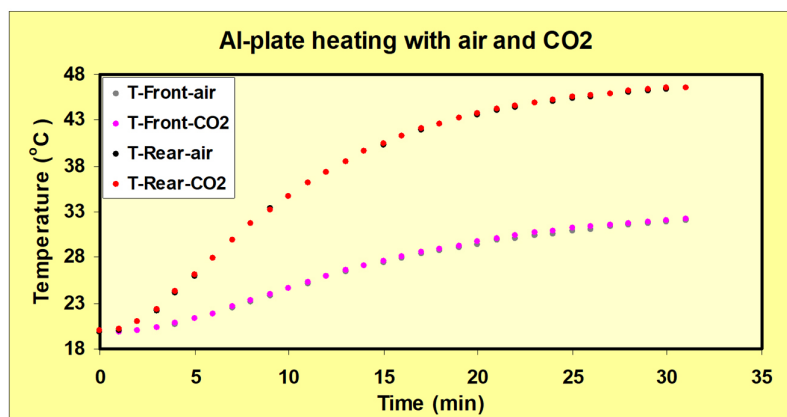

Figure 5. Heating of the two chambers is nearly identical with the front chamber filled with close to 100% CO₂ or air (with ca 400 ppm CO₂). Average values from five measurements are shown.

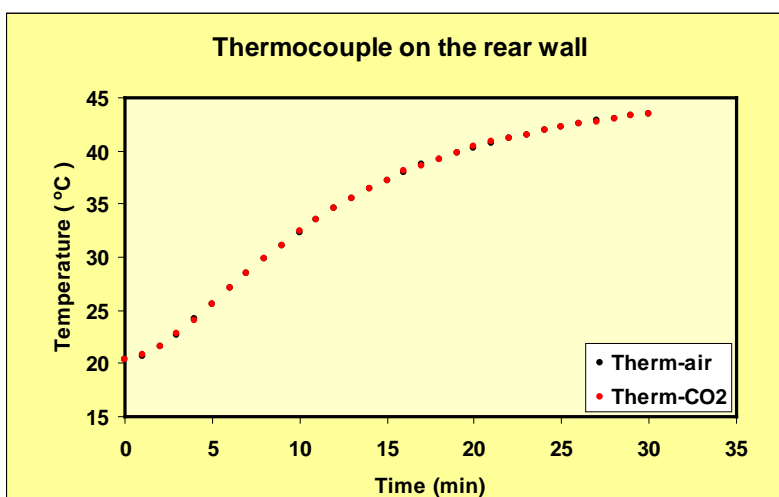

Figure 6. The measurement with a small thermocouple mounted on the rear wall and screened from radiation from the metal plate. Mean of three measurements.

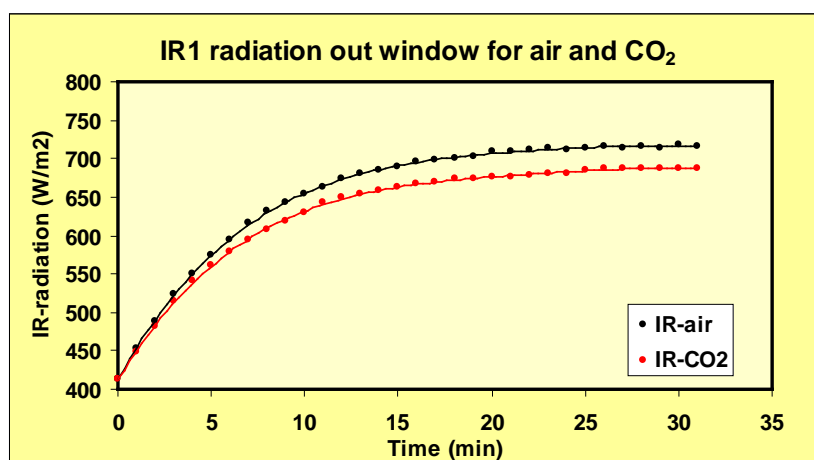

Figure 7. Absorption of IR radiation. Range: 2.5 - 20 μm . Heating is done with the Al-plate.

the window from 413 to 714.5 W/m^2 , *i.e.* with 301.5 W/m^2 with air in the front chamber. With CO_2 in the front chamber, the IR radiation decreased 29.8 W/m^2 or ca 10%. This is close to what we find from Equation (3).

For comparison the IR radiation from the rear wall was computed, using the Stefan-Boltzmann's law. For an ideal black body, the Stefan-Boltzmann's law is expressed as

$$E = \sigma T^4 \quad (4)$$

The area of the Al-plate is 0.036 m^2 and 0.114 m^2 for the Styrofoam area of the rear wall. The average temperature of the Al-plate is close to 100°C or 373 K, the Styrofoam rear wall is assumed to have the same temperature as the air (about 46.5°C or 319.5 K). The total IR radiation from the two sources is 107 W. The area of the front window is 0.15 m^2 and the computed IR energy output is then 713 W/m^2 , *i.e.* close to the measured value.

Comparing Expected with Measured Temperature Increments from Increased IR Radiation

We have computed how much the change in temperature and IR radiation will be due to air or 100% CO₂ in the front chamber.

For temperature computation the Equation (4) yields

$$T = \sqrt[4]{E/\sigma} \quad (5)$$

In **Figure 7**, we see an IR radiation reduction of 29.8 W/m² out of the front chamber when filled with CO₂. The temperature in the rear chamber increases from 20 °C to 46.5 °C or from 293 to 319.5 K after 30 minutes of heating (**Figure 5**). From Equation (4) the IR radiation E then increases from 417.9 to 590.9 W/m². If E in the rear chamber is increased with the same value as the reduction in the front chamber (29.8 W/m²), then Equation (5) gives an expected temperature of 323.5 K, or an increase in the temperature of 4.0 K, not close to zero, as measured.

3.3. Experiment with Argon

Argon is an inert gas that does not absorb IR radiation. When air was replaced by Argon in the front chamber the concentration of CO₂ in the chamber was reduced from 660 to about 200 ppm, but the heating curves for air and Argon were still close to identical (see **Figure 8**). The IR output through the front window was the same for both air and Argon in the front chamber, as expected.

3.4. Thermal Losses

The missing heating with CO₂ might be expected if there are significant thermal losses through the walls of the box, in particular the rear wall. Such losses might attenuate the temperature changes when air is replaced by CO₂ in the front chamber. Several modifications were therefore made to reduce thermal losses.

3.4.1. Heat Capacity of the Heating Plate

In **Figure 5**, the black-painted Al-plate is used to heat the chambers. The weight of the Al-plate was 274 grams. To reduce the mass of the heating plate, something

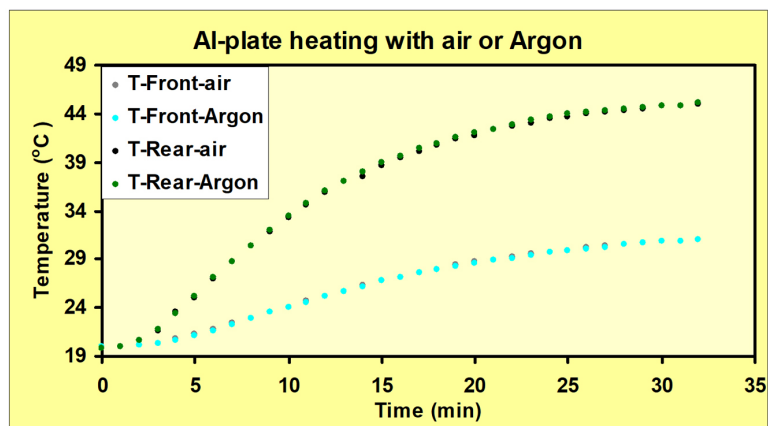

Figure 8. Heating with Al-plate. Mean values from three measurements are shown.

that might reduce the heating rate of the gases, it was substituted by a thin, black-painted Al-foil, weighing ca 6 grams, and the heating experiment was repeated. Again, the adding of CO₂ in the front chamber gave close to identical heating curves for the two chambers.

When we warm the thin Al-foil the temperature of the foil increases quickly to 85°C after ca 20 seconds and reaching a maximum value after ca 20 minutes. The average temperature of the plate is close to 100°C.

The Argon experiment was also repeated when the Al-plate was replaced with the Al-foil. The heating curves (mean of two experiments) again showed near-identical results.

3.4.2. Removing the Heating Plate and Increasing the Thickness of the Walls

To reduce the thermal losses through the walls the thickness was increased from 5 to 10 cm. In addition, the rear wall with the heating plate was removed and replaced with a 10 cm thick Styrofoam plate. A black-painted tissue paper sheet, weighing 14 grams, was mounted on the inside of the new rear wall. To heat the tissue paper two halogen projectors (without heat filters) was placed in front of the window of the box and focused on the rear wall. The heating was then repeated with air and CO₂, but the heating curves were again found to be close to identical for both gases.

3.4.3. Placing the Heating Plate inside the Rear Chamber

In order to be able to measure and control the input heating energy a new heating plate, consisting of an black painted Al plate and power resistors, was mounted on the inside of the rear Styrofoam wall. The AC voltage of the heating plate could be adjusted by a variac and measured with a digital voltage meter. The heating experiment was then repeated with air and CO₂, but the heating curves were again found to be close to identical for both gases.

3.4.4. Increasing the Power Output from the Heating Plate

The amount of absorbed IR through the front window, with CO₂ in the front chamber, was ca 10% (Figure 7). This has been compared to how much 10% increment of the power output from the metal plate, mounted inside the rear wall, raised the temperature. This simple test will also reveal if we have significant thermic losses in our setup. Heating was started with air in the front chamber. The power to the plate was increased 10% after 200 minutes, *i.e.* when the temperature had stabilized. The temperature at the start of heating was 17.9°C and it stabilizes at 50.0°C after 200 minutes. When the input power is increased by 10% it rises to 52.8°C, *i.e.* by 2.8 degrees.

From the Stefan-Boltzmann law (Equation (4)), we can compute the expected temperature rise.

We get $E(17.9^\circ\text{C}) = 406.0 \text{ W/m}^2$ and $E(50^\circ\text{C}) = 617 \text{ W/m}^2$. E then increases by 211 W/m^2 . When $E(50^\circ\text{C})$ increases by 10% or 21.1 W/m^2 , then Equation (5) gives $T = 52.7^\circ\text{C}$ *i.e.* an increase by 2.7°C . This is very close to the measured

temperature increment of 2.8°C, indicating that thermic losses must be small.

3.4.5. The Energy Budget

We calculated the absorbed energy in each part of our experimental setup during the heating curves by the density, specific heat capacity, etc. given in the Science Data Book [18]. The results are found in **Appendix A3, Table A1**. These values can be used to assure that no big heat sink will hide (conceal) the greenhouse effect we are looking for.

3.5. Measuring IR Backscatter

The IR backscatter was measured with the IR-detector placed behind the box (IR2) during heating with the Al-foil. The result is presented in **Figure 9**. After 40 minutes the backscatter in the rear chamber increased 17 W/m² with CO₂ in the front chamber. The measured backscatter is then about 80% of the reduced IR radiation out of the front window. From Equation (5) we then expect a temperature rise of 2.4°C, due to IR backscatter from CO₂.

3.6. Increased Temperature Sensitivity

Is the temperature increment with CO₂ too low to be detected by a single thermocouple? To check this, a thermopile was constructed, consisting of eight serial connected thermocouples and placed on the rear inner wall of the box. The measurement tip of the thermocouples was painted black with paint containing carbon in order to ensure heating by IR radiation. Finally, the voltage signal from the serially connected thermocouples was amplified 50 times. The advantage of this construction, compared to the IR detector used by us, was that the reference connection, with temperature T₂, was placed outside the box at room temperature. (The room temperature only increased 0.2°C during the experiment). The voltage was measured with a digital voltage-meter and found to be 36.5 mV per thermocouple. The CO₂ experiment was then repeated and the result is shown in **Figure 10**.

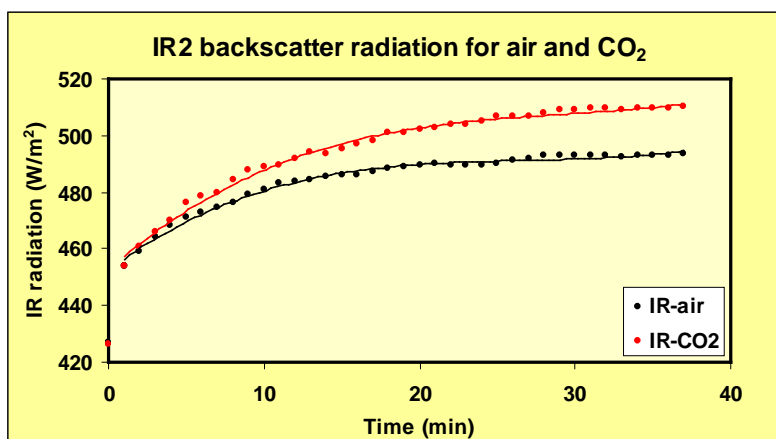

Figure 9. Backscatter (increased IR radiation measured by IR2), received by the rear wall of the box, increased 17 W/m² with CO₂ in the front box. Heating is done with the Al-foil.

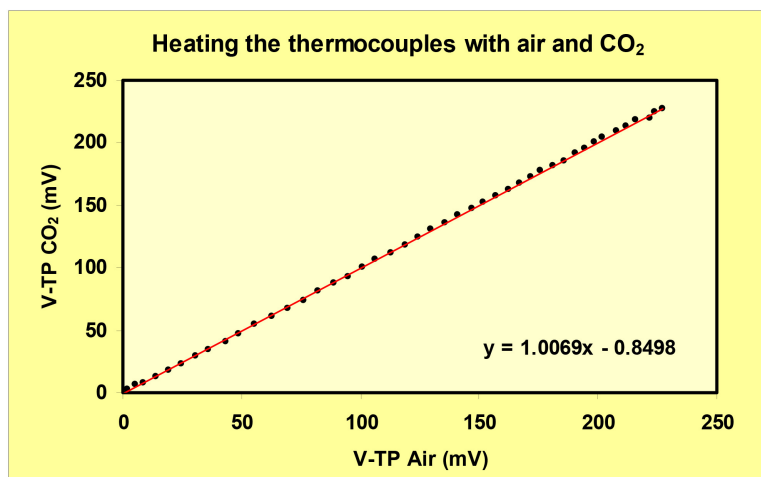

Figure 10. The thermopile shows only a slight extra heating with CO₂ instead of air in the front chamber.

Each axis in **Figure 10** contains the measured voltage of the thermopile during heating, with air (abscissa) and CO₂ (ordinate) respectively in the front chamber. In addition, a trend line and its formula are included in the figure. The trendline shows that there might be a very slight heating of the thermopile with CO₂ in the front chamber. The experiment was repeated several times and the average increment with CO₂ was ca 0.5%. For heating the air in the rear chamber from 20°C to 50°C, then the temperature increment, with CO₂ in the front chamber, should be ca. 0.15°C.

4. Discussion

Many references in the IPCC reports refer to the forcing of increased IR radiation on the temperature. This factor is much discussed [19] [20]. Our results show that the formulas used by IPCC Equation (1a) and Equation (1b) should give very large temperature changes. The values expected from the Stefan-Boltzmann law are much lower, but even these values were not detected in our warming curves. So the idea that backscatters from CO₂ is the main driver of global temperature increase might be wrong.

4.1. Losses Due to Volume Expansion

It could be argued that since we have constant pressure in the chambers, the extra heating due to CO₂ backscatter is lost due to extra work done by the gas on the atmosphere. But this work W is the same for all three gases. With constant pressure p it is given by:

$$W = p\Delta V = nR\Delta T \quad (6)$$

where ΔV and ΔT is the change in volume and temperature, n the number of moles and R is the ideal gas constant. Since the expansion of the gases, and the work done by volume expansion, only take place during heating and not at the final steady-state, the computation of expected temperature increase, with CO₂

in the front chamber (Section 3.2.1), is assumed valid. In the final steady state the extra energy flow from backscatter IR continues with ca 180 J per minute ($20 \text{ W/m}^2 \times 0.15 \text{ m}^2 \times 60 \text{ sec}$) and should lead to increased temperature.

4.2. Temperature Sensitivity

To measure IR radiation we used a detector containing a thermopile. Both the thermocouple and the thermopile utilize the Seebeck effect [21]. The thermocouple works as follows: It is constructed from two different metals/conductors that are connected in a small (ca 1 mm) sensor with temperature T_1 . The other end of the two metal wires, with the temperature T_2 , is connected to a digital voltage meter. When $T_1 > T_2$ the open-circuit voltage ΔV obtained is proportional to the temperature difference between the two junctions, according to the Seebeck effect:

$$\Delta V = S \times (T_1 - T_2) \quad (7)$$

where S is the relative Seebeck coefficient. In a thermopile, a number of thermocouples are serially connected, thus increasing the sensitivity of the detector considerably.

When the thermopile in the IR detector is heated by absorbed IR radiation its voltage response increases. The detector heats up and increases its voltage when irradiated by IR from CO_2 . So why did the 8-element thermopile we constructed give only a very small response to increased IR backscatter? The answer lies in the construction of the IR detector. Its thermopile is encapsulated and the air surrounding the detector capsule cannot remove heat from it, as it happens for the one we constructed. For the IR detector used by us, the temperature sensitivity was $11 \mu\text{V}/^\circ\text{C}$, but for the 8-element thermopile the sensitivity was only ca. $1.2 \mu\text{V}/^\circ\text{C}$. The reason is that the IR detectors are equipped with a large number of thermocouples. A Google search on the Internet revealed detectors that contained between 80 and 200 thermocouples! So the engineers, constructing these devices, seem to know that the heating response is very small and that the number of thermocouples needs to be large.

5. Conclusion

The results of our study show the near-identical heating curves when we change from air to 100% CO_2 or to Argon gas with low CO_2 concentration. Nevertheless, we observed absorption of IR radiation in the front chamber. We also observed the increased radiation density in the rear chamber due to the backscatter from CO_2 . The change in observed backscatter radiation should give us a measurable temperature increase of 2.4 to 4 K by using the Stefan Boltzmann law. But we only observe a very slight temperature increase due to CO_2 backscatter. This indicates that heating, due to IR backscatter from CO_2 , is much less than what is assumed from the Stefan Boltzmann law or from the forcing Equation (1a) and Equation (1b). The near-identical heating curves for all the three gases indicate that the thermal energy transfer is only driven by the temperature of the back

wall of the rear chamber. Without extra heating of the walls in the rear chamber, the air temperature cannot increase. These findings might question the fundament of the forcing laws used by the IPCC. Another possibility is that our setup has unexplained heat losses that cancel the effect of the increased backscatter IR and prevent higher temperatures in the rear chamber, but after testing this and finding only slight losses, we do not see that this could be the case.

Acknowledgements

We would like to thank Prof. Øyvind Grøn (Institute of Physics, University of Oslo) for careful reading of the manuscript and fruitful comments.

Conflicts of Interest

The authors declare no conflicts of interest regarding the publication of this paper.

References

- [1] Tyndall, J. (1859) On the Transmission of Heat of Different Qualities through Gases of Different Kinds. *Proceedings of the Royal Institution*, **3**, 155-158.
- [2] Figure 1 Is Modified from Figure in. <https://skepticalscience.com/empirical-evidence-for-co2-enhanced-greenhouse-effect-intermediate.htm>
- [3] Houghton, J.T., Meira Filho, L.G., Griggs, D.J. and Maskell, K. (1997) An Introduction to Simple Climate Models Used in the IPCC Second Assessment Report. IPCC Technical Paper II—February IPCC, Geneva, 51.
- [4] Benestad, R.E. (2006) *Solar Activity and Earth's Climate*. Springer, Berlin.
- [5] Pierrehumbert, R.T. (2011) Infrared Radiation and Planetary Temperature. *Physics Today*, **64**, 33-38. <https://geosci.uchicago.edu/~rtp1/papers/PhysTodayRT2011.pdf>
<https://doi.org/10.1063/1.3541943>
- [6] Harde, H. (2017) Radiation Transfer Calculations and Assessment of Global Warming by CO₂. *International Journal of Atmospheric Sciences*, **2017**, Article ID: 9251034. <https://doi.org/10.1155/2017/9251034>
- [7] Philipona, R., Dürr, B., Marty, C., Ohmura, A. and Wild, M. (2004) Radiative Forcing—Measured at Earth's Surface—Corroborate the Increasing Greenhouse Effect. *Geophysical Research Letter*, **31**, L03202. <https://doi.org/10.1029/2003GL018765>
- [8] Feldman, R., *et al.* (2015) Observational Determination of Surface Radiative Forcing by CO₂ from 2000 to 2010. *Nature*, **519**, 339-343. <http://www.nature.com>
<https://doi.org/10.1038/nature14240>
- [9] <https://phys.org/news/2015-02-carbon-dioxide-greenhouse-effect.html>
- [10] IPCC Assessment Report 4. <https://www.ipcc.ch/site/assets/uploads/2018/03/ar4-wg1-chapter1.pdf>
- [11] IPCC Fifth Assessment Report (2013). http://climate.envsci.rutgers.edu/climdyn2013/IPCC/IPCC_WGI12-RadiativeForcing.pdf
- [12] IPCC Fifth Assessment Report. Anthropogenic and Natural Radiative Forcing Supplementary Material.

- https://www.ipcc.ch/pdf/assessment-report/ar5/wg1/supplementary/WG1AR5_Ch08SM_FINAL.pdf
- [13] IPCC Fourth Assessment Report (2007) Climate Change 2007. https://www.ipcc.ch/publications_and_data/ar4/wg1/en/ch2s2-2.html
- [14] Myhre, G. D., *et al.* (2013) Anthropogenic and Natural Radiative Forcing Supplementary Material. In: *Climate Change 2013: The Physical Science Basis*. Contribution of Working Group I to the Fifth Assessment Report of the Intergovernmental Panel on Climate Change. Anthropogenic and Natural Radiative Forcing Supplementary Material, 16. https://www.ipcc.ch/site/assets/uploads/2018/07/WGI_AR5.Chap_8_SM.pdf
- [15] HITRAN Database. <https://www.cfa.harvard.edu/hitran>
- [16] Data from HITRAN. <http://www.realclimate.org/index.php/archives/2007/06/a-saturated-gassy-argument-part-ii>
- [17] Data for the IR Detector Used. https://www.te.com/commerce/DocumentDelivery/DDEController?Action=showDoc&DocId=Data+Sheet%7F7TS105-10L5.5%7FA%7Fpdf%7FEnglish%7FENG_DS_TS105-10L5.5_A.pdf%7FG-TPCO-019
- [18] Tennent, R.M. (1971) Specific Heat Capacity Is Taken from Science Data Book. Oliver & Boyd, Edinburgh.
- [19] Stallinga, P. (2020) Comprehensive Analytical Study of the Greenhouse Effect of the Atmosphere. *Atmospheric and Climate Sciences*, **10**, 40-80. <https://www.scirp.org/journal/paperinformation.aspx?paperid=97917>
<https://doi.org/10.4236/acs.2020.101003>
- [20] Lindzen, R.S. (1993) Climate Dynamics and Global Change. *Annual Review of Fluid Mechanics*, **26**, 353-378. <https://doi.org/10.1146/annurev.fl.26.010194.002033>
- [21] The Seebeck Effect. https://en.wikipedia.org/wiki/Thermoelectric_effect

Appendix

A1. Calibration of the IR Detectors

To measure IR radiation we used thermopile detectors. We used a wide-band detector with a close to constant response from 3 to 24 μm [17]. The field of vision for the detector was \pm five degrees. The voltage signal from the detectors was amplified by a factor of 120, using an operational amplifier.

The calibration procedure, performed in room temperature, was as follows:

To obtain a radiation spectrum close to that of a black radiator we used a black iron pan, filled with water of temperature of 100°C and allowed fall to 15°C. (The blackness of the iron pan was created by burning in a layer of oil, forming a layer of black carbon). The temperature of the pan was measured with a Fluke 62 Max IR thermometer and the voltage output of the detectors was measured with a digital voltmeter. See **Figure A1**. In addition, we computed the IR energy output E (W/m^2) from the pan, using Equation (4) (the Stefan-Boltzmann's law). The result is shown in **Figure A2**.

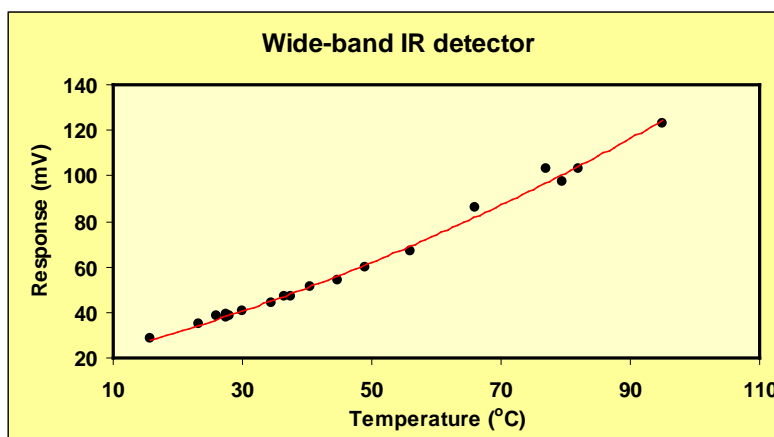

Figure A1. The output voltage (in mV) from the wide-band IR detector as function of temperature.

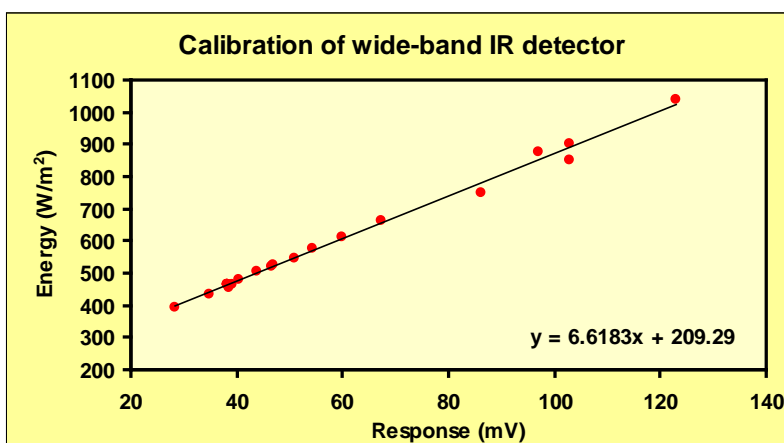

Figure A2. The output of a black body radiator in W/m^2 is a linear function of the output signal from the IR detector (in mV). The formula of the trend-line (black) is also shown.

A2. Increasing the Accuracy of the Measurements

To obtain high precision in the temperature measurements we must control external factors that might lead to deviating results. One is the AC voltage that may vary during heating. This will change the energy output from the halogen lamp. The AC voltage was monitored/adjusted by using a digital voltmeter with high resolution. We also measured the variation in the output of the lamp when the AC voltage varied about 5% and found that if the variation was less than 1% a very slight variation was found in the light output from the lamp. If the voltage fluctuated more than 1% the experiment was repeated.

The other main factor that will influence the measurement is a variation in room temperature between the two measurement series (first with air in the front chamber, then with CO₂ or Argon). If the room temperature varied the temperature curves altered. As control two measurements were made where we changed the room temperature 0.9 degrees. See **Figure A3**.

By adding the difference of the two-room temperatures to the lower curve in **Figure A3** gave a common start value for both curves and two near-identical curves with a common end temperature. See **Figure A4**. In the experiments, this adjustment was made if the room temperature varied, but only if the variation was less than one degree. Normal variation was about 0.4°C.

A3. The Kinetic Energy Account

From the specific heat capacity, the mass of the gases and material used and the temperature increase of the gases in the two chambers, we calculate the heat absorbed [18]. During the 30 minutes of warming, the temperature increased by ca 10 K in the front chamber and ca 25 K in the rear chamber. The volume of the front chamber is 105 liters and the rear chamber contains 45 liters. Data for the material and gases used in the experiment is found in **Table A1**.

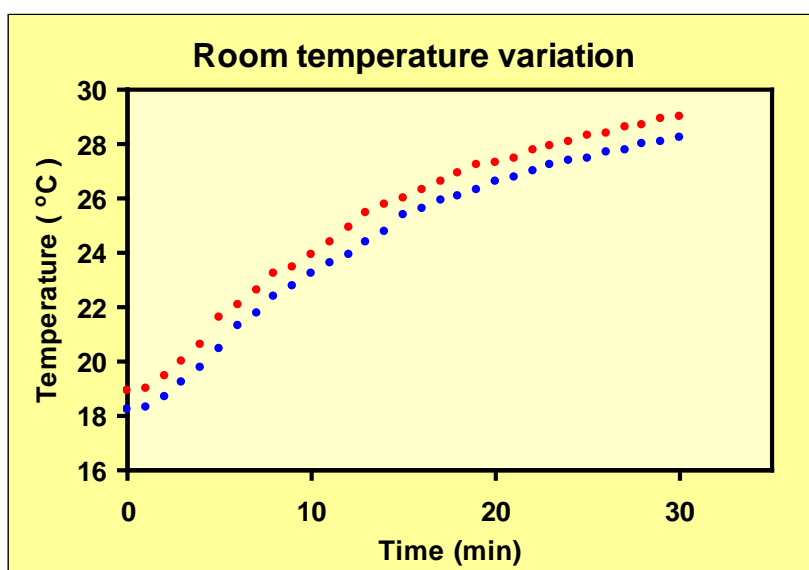

Figure A3. Heating curves for two room temperatures in the front chamber.

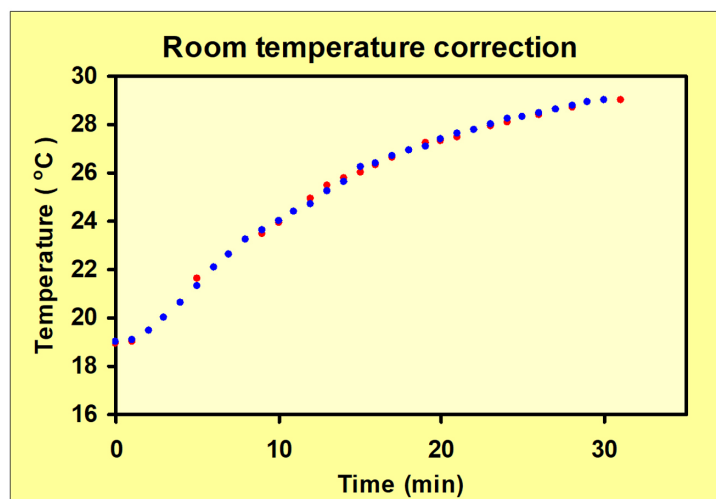

Figure A4. Adjusting the curves for the change in room temperature resulted in a common temperature curve.

Table A1. The properties of the gases, expanded polystyrene and aluminum at S.T.P [18].

	Density (kg/m ³)	Mass in front chamber (kg)	Mass in rear Chamber (kg)	Specific heat capacity Cp (J/kg × K)	Heat (J) absorbed in Front chamber $\Delta T = 10\text{K}$	Heat (J) absorbed in Rear chamber $\Delta T = 25\text{K}$
Air	1.293	0.136	0.058	993	1348	1444
CO ₂	1.977	0.208	0.089	834	1731	1855**
Argon	1.784	0.187	0.080	524	982	1052**
Styrofoam 1 cm*	15.6	0.175	0.093	1300	1137, $\Delta T = 5\text{K}$	1209, $\Delta T = 10\text{K}$
Al-plate heating			0.274***	880		6028, $\Delta T = 25\text{K}$ 24,112, $\Delta T = 100\text{K}$
Al-foil heating			0.006***	880		132, $\Delta T = 25\text{K}$ 528, $\Delta T = 100\text{K}$
Al-foil all walls		0.050***		880	616 (weighted average from both chambers)	

*The temperature of the outside walls increases ca 1 °C, partly due to increased room temperature. Based on the temperature gradient in the walls we assume that this is equivalent to heating about 1 cm of the wall material in the 30 minutes to $\Delta T = 5\text{K}$ in the front chamber and 10 K in the rear chamber. **If those gases were also placed in the rear chamber, included for comparison only. ***Measured weight of material.